



Genie XS

PROFESSIONAL MICRO AUTOSCRUBBER



“Cleaning
ON DEMAND”

Cleaning
“wherever” and
“whenever” you want



Suitable for cleaning small surfaces



- Effortless and comfortable to use
- Perfect washing and drying in any direction thanks to the parabolic squeegee
- Increases hygiene level
- The floor is dry within few seconds
- Equipped with maintenance-free lithium ion battery
- You can use Fimap detergents to increase cleaning performances
- Handy for everyday use
- Environmental friendly, reduces water consumption

EASE OF USE

The controls on the steering wheel are simple, intuitive and easy to use also by inexperienced operators



“AUTO” device: all cleaning settings are already pre-configured, just press the button to activate



 Water and detergent

 Vacuum

 Brush

COMFORT

Adjustable height
to avoid back fatigue



Parabolic squeegee



The innovative rotary head is equipped with a parabolic squeegee which continuously follows the direction of the machine, for perfect washing and drying results in any direction and even in the most inaccessible corners.



VERSATILITY



Parabolic squeegee

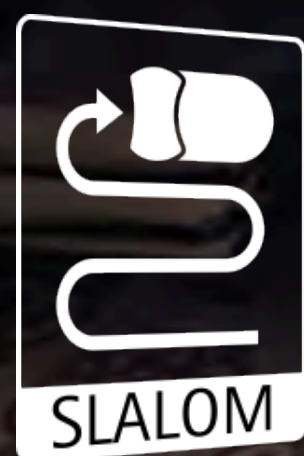

SLALOM
CLEANING



VERSATILITY

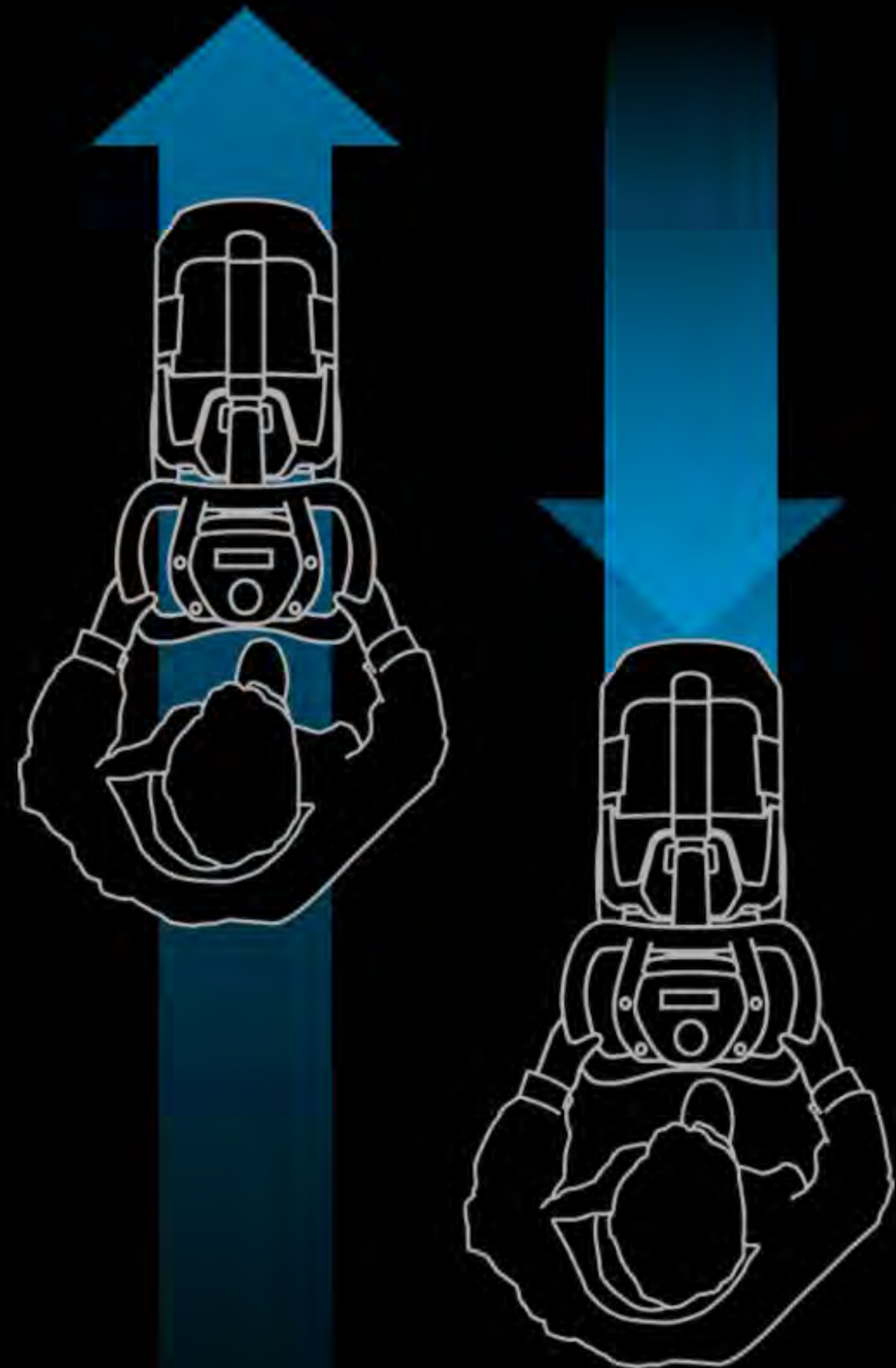

Scrubs and dries in one go both forwards and backwards

VERSATILITÀ



0 mm

Reaches right up to skirting boards,
cleaning the entire floor area



Cleans right into the corners

 FIMAP®

VERSATILITY



Reduced
height

HYGIENE

Antibacterial tanks

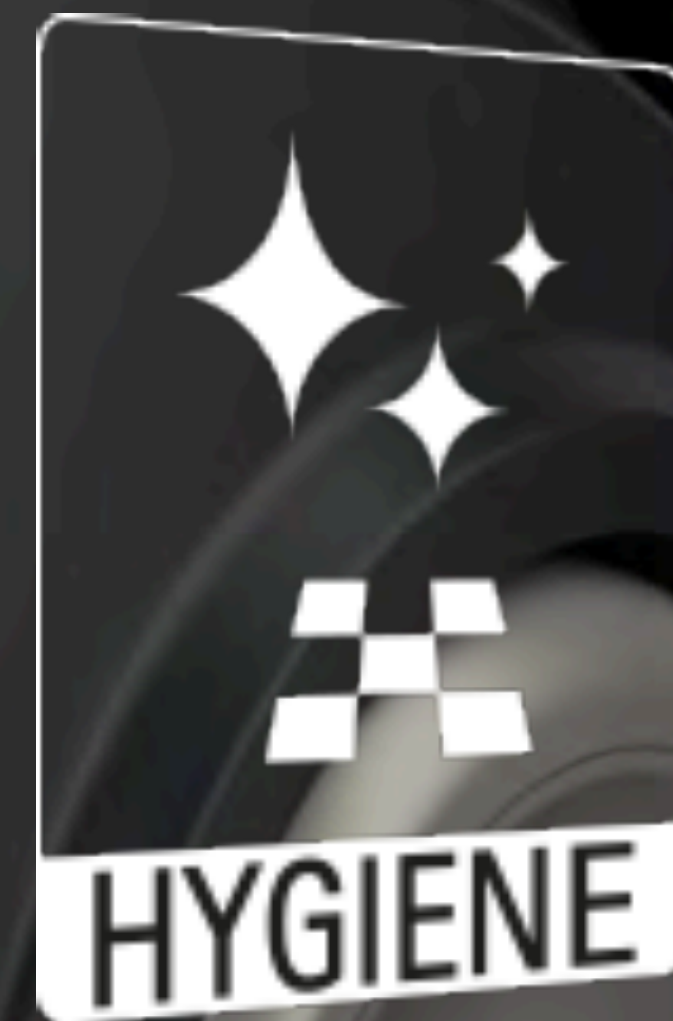



Immediately dry floor



No slip and fall accidents



No more time wasted to wait for the floor to dry



No more safety signs to close the area

INNOVATION

LITHIUM-ION BATTERY
TECHNOLOGY



 **FIMAP**® & **SAMSUNG** alliance





LITHIUM-ION BATTERY TECHNOLOGY

ENERGY CONSUMPTION

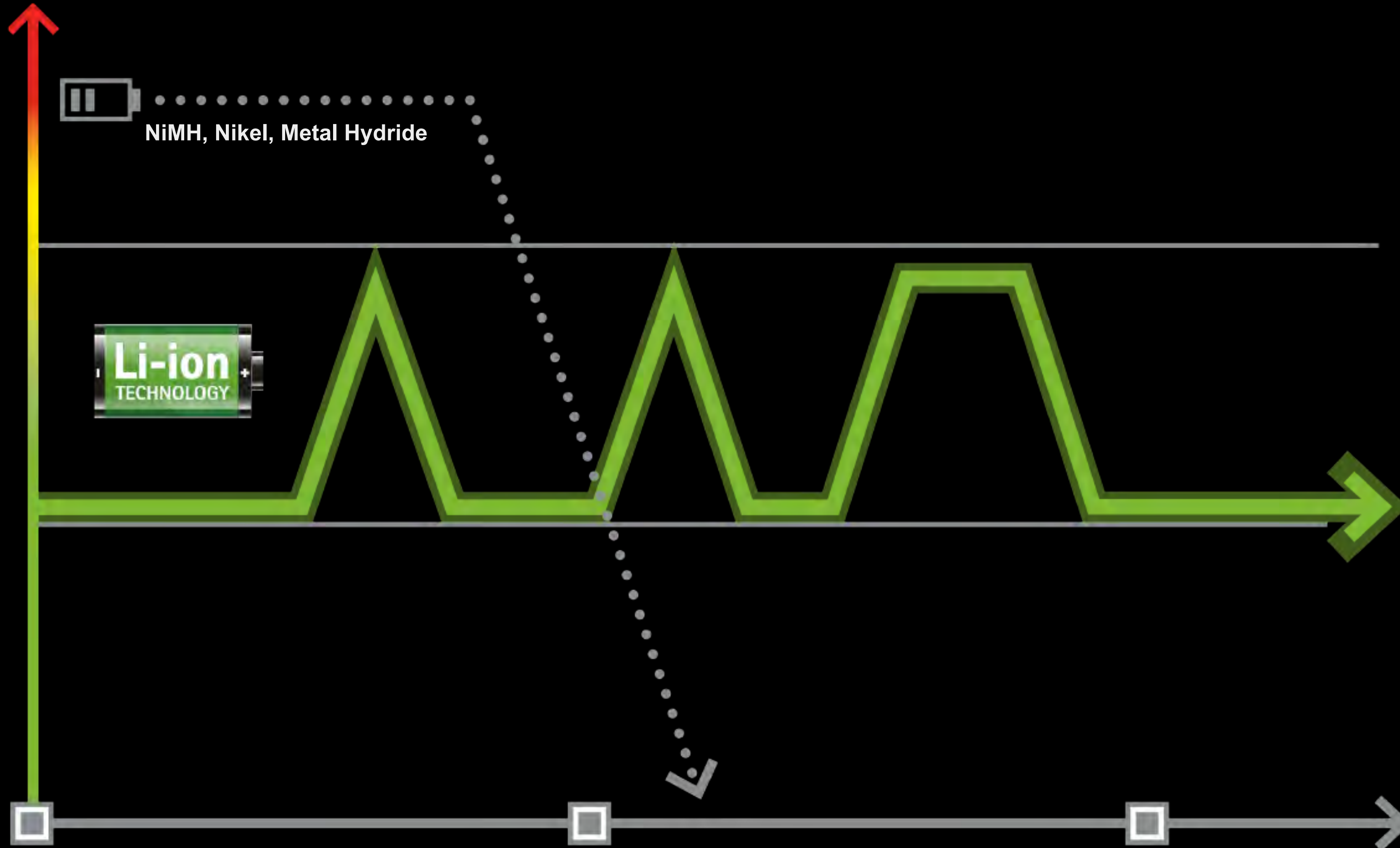

NiMH, Nickel, Metal Hydride

MAXIMUM POWER for dirty floors

If the dirt is stubborn and difficult to remove, the machine delivers more power

MAXIMUM ENDURANCE for maintenance cleaning

When the dirt is lighter, power returns to normal levels thus the battery lasts longer

ENDURANCE (over time)



MAXIMUM POWER

Increased power only when needed



MAXIMUM ENDURANCE

Under normal dirt conditions, the power remains constant, increasing battery endurance



ALWAYS READY TO USE

No self-discharge, Genie XS is always ready when you need it
No memory effect, you can recharge the battery whenever you want



QUICK CHARGE

You can use Genie XS several times in the same day



LOW RUNNING AND MAINTENANCE COSTS

High discharge/charge cycle lifespan



COMPACT DESIGN

Lithium batteries allow for a compact and lightweight design

INNOVATION



HANDY BATTERY CHARGER

Lets you recharge it anywhere,
without wasting time

TRANSPORTABILITY



Like a trolley



By the handle



Lifting

COMPACT

Space saving storage
(vertical parking)





Fimap recommends to use the Chemical Cards that contain low-foaming detergents that:

- do not leave residues
- do not clog the pipes
- help to keep your scrubbing machine always at its best conditions

CHOOSE THE CHEMICAL CARD THAT IS RIGHT FOR YOU



BLUE BLOSSOM CLEANER

for all kind of hard floors



ORANGE CITRUS CLEANER

for hardwood and parquet floors



GREEN PINE SANITIZER

to sanitize healthcare environments

Benefits of the Chemical Cards:

- They're handy to use, because they contain just the right amount of detergent
- They're easy to use. Just bend the card between two fingers and pur out the contents
- They're safe. You never come into contact with the chemical product
- They're practical. The space-saving format means they're easy to store and to carry with you



QUICKLY READY TO USE



The water tank small size allows to fill it up in any situation

QUICKLY READY TO USE



The squeegee is lowered
and lifted by a handy knob

QUICKLY READY TO USE

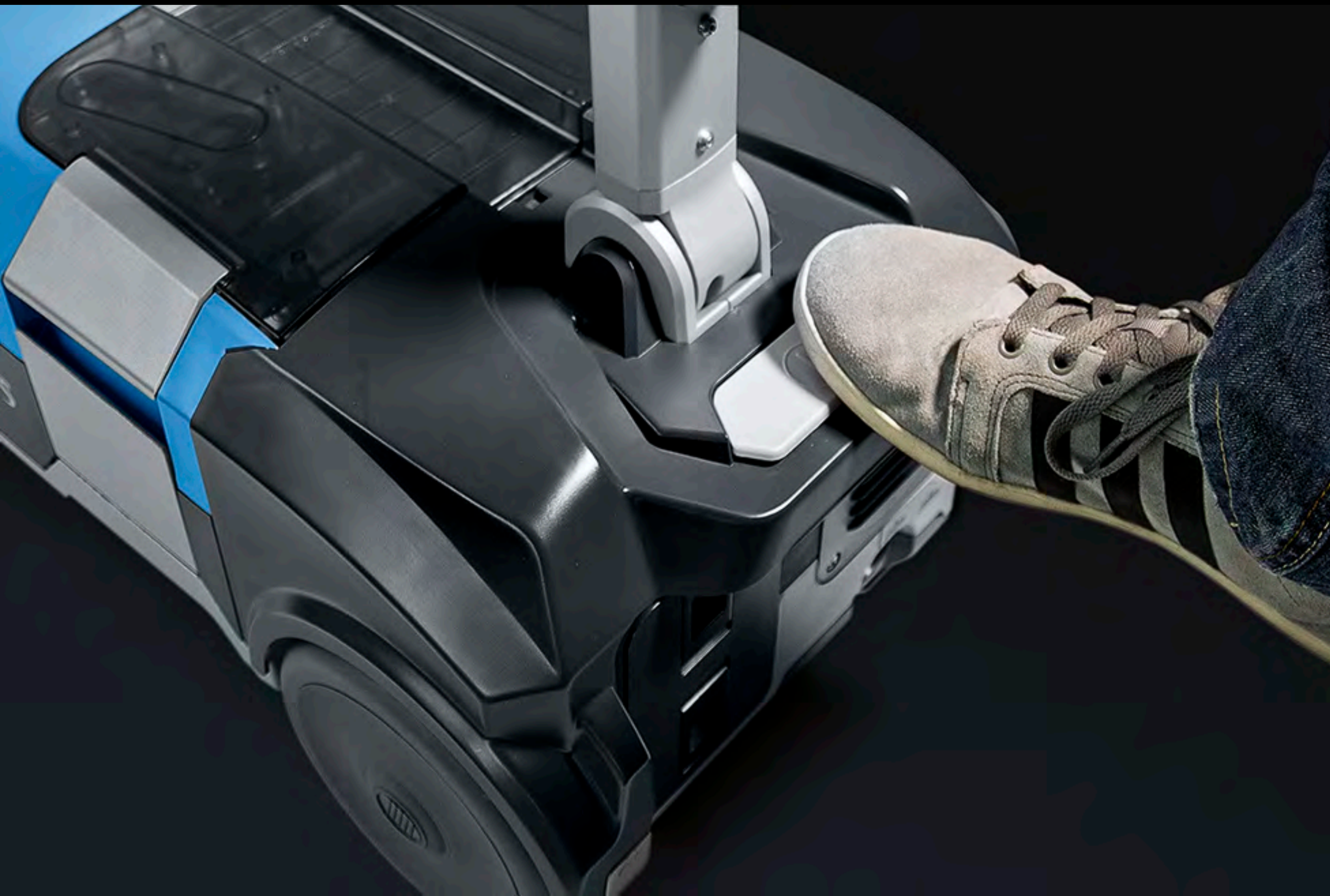

Pedal switch

DAILY CARE



Vacuum cover

Recovery tank



Solution tank

The recovery tank is quick and easy to empty



The solution filter cleaning guarantees a proper water flow on the brush

The proper cleaning of
the vacuum cover...



... and hose ensures
constant drying performances





Easy brush replacement without
any tools

DAILY CARE



The squeegee blades are easy to clean at the end of work and to replace when worn

Their proper maintenance ensures perfect floor drying



SUSTAINABILITY



 Noise level reduction

 Energy saving

 Water and detergent saving



High quality components

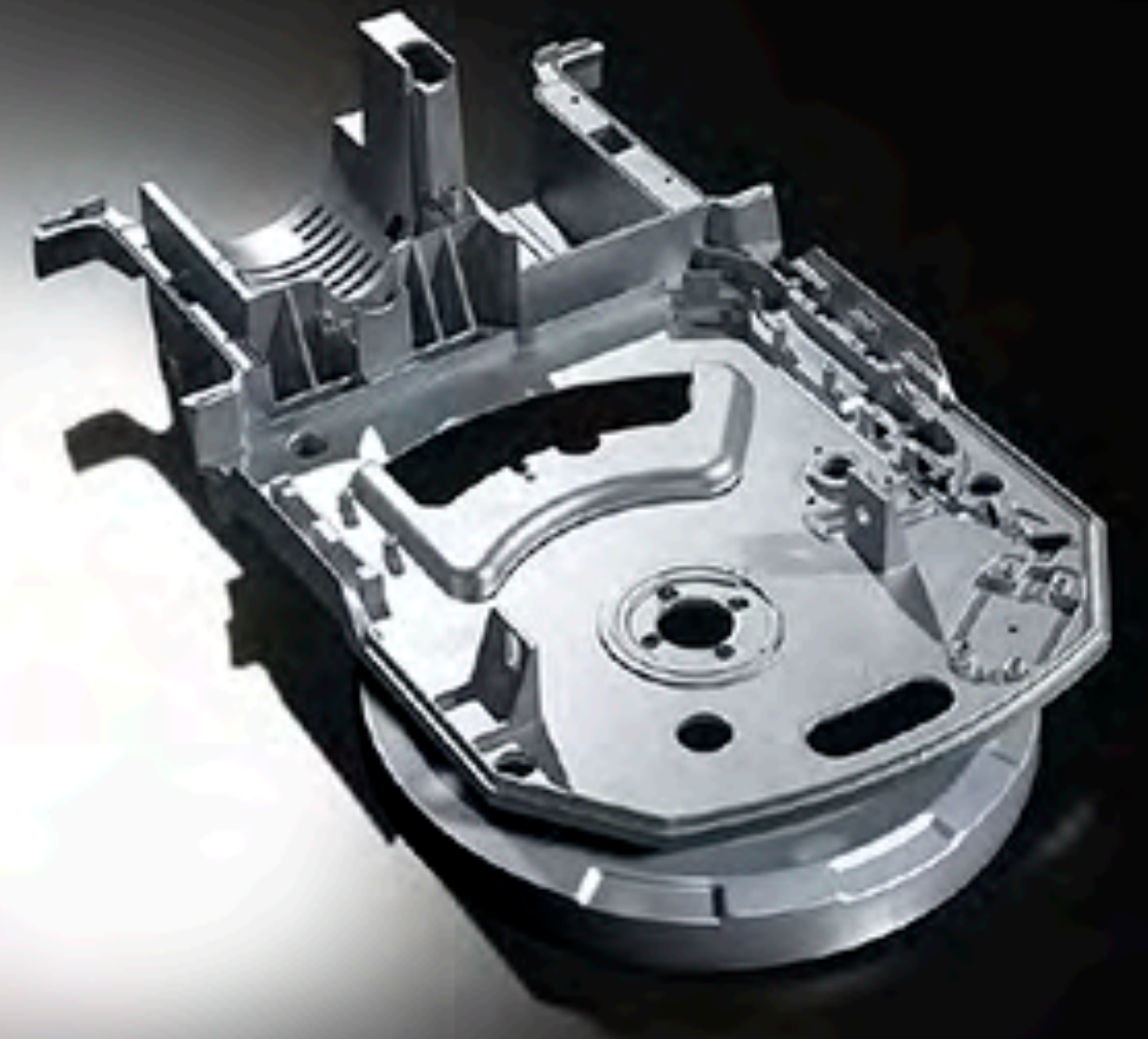

90% of recyclable materials

SCHEDA AMBIENTALE
ENVIRONMENTAL CARD

Genie XS Lavasciuga pavimenti uomo a terra
Walk-behind scrubbing machine



CONSUMO DI SOLUZIONE DETERGENTE
DETERGENT SOLUTION CONSUMPTION



Calculation method verified by TUV Italia

1.4 l/100 m² - l/100 sq.m

CONSUMO ENERGETICO
ENERGY CONSUMPTION



Calculation method verified by TUV Italia

0.399 Wh/m² - Wh/sq.m

LIVELLO DI PRESSIONE ACUSTICA
SOUND PRESSURE LEVEL (ISO 11201)



65.7

LpA/Eco Mode dB (A)



MATERIALI RICICLABILI A FINE VITA DELLA MACCHINA
RECYCLABLE MATERIALS AT THE END OF MACHINE LIFE CYCLE



90 %

TECNOLOGIE - TECHNOLOGIES



Genie XS

CERTIFICAZIONI DI PRODOTTO - PRODUCT CERTIFICATIONS



CERTIFICAZIONI AZIENDALI - COMPANY CERTIFICATIONS



Genie XS numbers



TECHNICAL DATA		Genie XS
Working width	mm	280
Squeegee width	mm	325
Clean water tank	l	3
Dirty water tank	l	4
Cylindrical brush Ø	mm	280
Battery type	V/Ah	Li-ion
Brush motor	V/W	36/90
Suction motor	V/W	36/150
Noise level	dB(A)	<70
Machine weight (with battery)	Kg	20
Working capacity	Up to sq. m.	900
Machine dimensions (L x h x l)	mm	555 x 1050 x 375



Label certification
for the transport
of dangerous
material

Packaging
certification

Li-ion Battery Certification

 **FIMAP**[®]

MODEL : 440141
T Y P E : Rechargeable Li-ion BATTERY
RATING : 36.50V 189.8Wh 5200mAh
10INR19/65-2

 **CAUTION**

Please refer to manual before using battery.
Veuillez consulter le guide d'utilisation
avant d'utiliser la pile.
Referez-vous au mode d'emploi
avant d'utiliser la batterie.
Consulte o manual antes de usar a bateria.
Por favor lea el manual antes de utilizar la batería.



   [®] **US**
MH29634

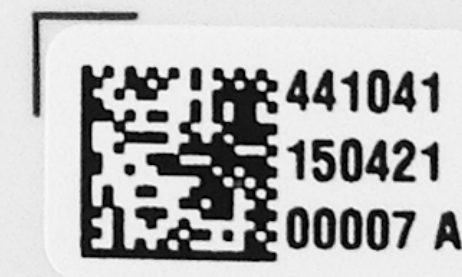

Patent Pending



Overlapped tanks

Parabolic squeegee



Brush coupling/uncoupling

Elimination of flexible hoses (vacuum cover)





Ownership of the information and/or documents:

All information (by which we mean all data and information with the sole exception of that of common knowledge or which FIMAP has disclosed without reserve) and all documents (drawings, photos, etc.) are the exclusive property of FIMAP and their use does not mean there is any kind of acquisition of titles, property or exploitation of rights or licenses except for the limited permission of use ruled by this document.

By way of example and, therefore, not limited to, such information and/or documents can be the following:

Marketing section:

high definition digital images for the implementation of commercial catalogues on paper or web sites, company trademarks, original graphical documents from which texts are taken (e.g. the descriptive notes), PDF documents and original documents in .ppt format.

Professional use of the data:

It is a known fact that the information and/or documents, subject of this commitment, are and will be used by the beneficiary exclusively for carrying out his professional business and, therefore, no specific laws regarding consumer protection are applicable.

Confidentiality:

The Party that benefits from the information or use of documents taken from or, in any case, part of the commercial documentation, shall use all such information and/or documents with maximum care solely for the purposes connected to execution of this contract with FIMAP and shall:

keep such information and/or documents confidential except for those, due to their nature, which are to be disclosed (promo-advertising material etc.); shall not divulge any information and/or document to its suppliers, collaborators or employees beyond what is strictly necessary so that they may fulfil their tasks concerning relations with FIMAP and shall ensure that the suppliers, collaborators and employees that have access to the information and/or documents are, in turn, bound by a confidentiality commitment to the benefit of FIMAP; shall not divulge any information to third parties without the prior written consent by FIMAP; copy and/or in any other way reproduce any information or document without the prior written consent of FIMAP; take all the necessary measures to protect confidentiality.

Returning information and/or documents:

Whilst maintaining exclusive ownership at all times, FIMAP has the right, at any time, to ask in writing or by e-mail, that all the information and/or documents received be returned or no longer used and within the term of thirty days from receipt of this request, all the information and/or documents must be returned, including any copies, or destroy such information and/or documents and relative copies so as to prevent them from being recovered and FIMAP must be given a written declaration certifying that the information and/or documents have all either been returned or destroyed.

This obligation to return, destroy or no longer use is set automatically in motion when the relationship is cancelled with FIMAP for any reason whatsoever.

Applicable law, cancelling clauses and Court having jurisdiction:

The interpretation, integration, execution and the effects of this commitment will be governed by Italian law.

If one or more points of this agreement are cancelled it does not invalidate the remaining points.

All disputes will be put to the exclusive jurisdiction of the Verona Courts.