

GMG



Amazing in any challenge

 FIMAP®

GMG



Reduce cost to clean and get the greatest return on your investment in short term

POWER

- Increase productivity, by cleaning with greater power and 30% faster than a conventional model of the same category
- Increase productivity, by cleaning ramps with slopes up to 20%
- Increase productivity, with the possibility to install batteries of different technologies, from lead acid batteries to advanced lithium-ion ones, which provide up to 10 hours of run time on a single charge
- Reduce the time required for U-turns within logistics centres aisles, by changing direction in one smooth manoeuvre
- Increase operator productivity, with enhanced control over tasks provided by the touchscreen display and the rear view camera
- Increase operator productivity, providing up to 9 pre-set cleaning programs according to different applications
- Save on operating costs, with the low maintenance required by brushless motors

SPEED

up to **9** km/h
at work

PRODUCTIVITY

+30%

GRADEABILITY

slopes up to **20%**
working

RUN TIME

up to **10** hours





SIMPLICITY

- Reduce operator training, with on-board video tutorials which show how to perform common operation and maintenance activities
- Increase uptime, with easy and intuitive access to key features through the iD – Intelligent Drive system
- Enhance control over cleaning results, with pre-set work programs and supervisor controls that ensure proper machine setting and use by the operator
- Reduce service time and cost, with fully accessible design that enables easy and quick servicing

SUSTAINABILITY

- Reduce the use of resources, saving water, chemical and energy thanks to Fimap sustainable technologies
- Reduce the environmental impact, with constant control of the CO₂ produced
- Reduce water use up to 66% with FLR – Fimap Long Range technology, that allows you to clean more sq.m with the same amount of resources

FSS
 up to **50%**
reduces water and chemical use

FLR
 up to **66%**
reduces water and chemical use

DURABILITY

- Protect the machine and the facility in which it works, with steel wrap-around bumper and roller bumpers at the 4 corners

SAFETY

- Increase operator and facility safety, thanks to the array of active and passive safety technologies provided as standard

CONNECTIVITY

- Increase productivity by tracking performance with Fimap My.Machine app

CUSTOMIZATION

- Increase productivity by customizing GMG to your specific needs

GMG

A scrubbing machine designed to exceed your expectations in the most demanding industries



LOGISTICS



PARKING LOTS



TRANSPORTATION



INDUSTRY



LARGE-SCALE
RETAIL



Accurate details highlight the robustness of its design

It stands out for the strength of its design that enhances the sense of protection



PROTECTION

- **FOR ENVIRONMENTS**
It blends in perfectly, has no protruding parts
- **FOR THE USER**
It has a comfortable and safe driving position that enhances visibility and control
- **FOR THE MACHINE ITSELF**
Long-lasting, rotationally moulded plastic tanks and steel wrap-around bumper protect mechanical components, while rear sensors prevent potential collisions by warning when approaching an obstacle



● BRUSHLESS MOTORS

Motors without brushes bring several advantages:

- **MORE POWER**,
which is entirely used avoiding the dispersion that is normally caused by the friction of the brushes
- **GREATER DURABILITY OVER TIME**,
as they do not generate heat, there is no need for ventilation which can cause damaging seepages
- **COMPACT DESIGN**,
they leave more space to the volume of the tanks, thus increasing the working autonomy
- **GREATER CONTROL**,
which being electronic, and not electromechanical, automatically adjusts to the required performance, improving efficiency
- **NO MAINTENANCE**
and extremely longer life cycle

ENDURANCE OVER TIME

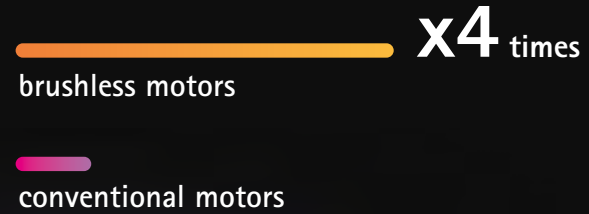

The roller bumpers at the 4 corners deflect shocks protecting the machine and extending its life

Components close to the floor and therefore in contact with water are made of stainless steel and treated aluminium, so they are resistant to corrosion

GMG

A comfortable space enables the operator to better focus on the cleaning task

Every single detail of the driving position is designed to provide the perfect working conditions: a comfortable seat, easy access to controls, full control of activities, smooth manoeuvres, total visibility of the surrounding space



The Eco Mode device reduces the noise level to clean without disturbing the other people around



A convenient step helps to sit in the driver's seat

Side paddles integrated into the steering wheel help the operator keep his attention and eyes on the driving direction

The digital touch screen display creates a modern, high-tech environment where valuable information is shown in high resolution

The side control panel provides easy access to functions, allowing the operator to work on settings without getting distracted

Integrated USB ports for charging mobile devices



Comfort driver's seat

The seat, with armrests and headrest, is sprung and adjustable, to suit the operator's needs, thus improving driving comfort



GMG

Learning how to take care of GMG is easy,
because it is the machine itself that guides you



They provide essential instructions to perform routine activities and to support the operator when a quick reminder is needed on proper operation and maintenance procedures

OPERATOR
TRAINING
VIDEO
TUTORIALS



USE AND MAINTENANCE MANUAL
AND SPARE PARTS CATALOGUE

It is possible to read directly from the display the Spare Parts Catalogue and the Use and Maintenance Manual, available in 24 languages. Any doubts concerning the machine can be solved immediately, thanks to the easy-to-read touchscreen display.



SERVICE LIGHTS



The exclusive lights pack offers increased visibility of the parts which could require operator inspection, illuminating the relative zones with LED lights

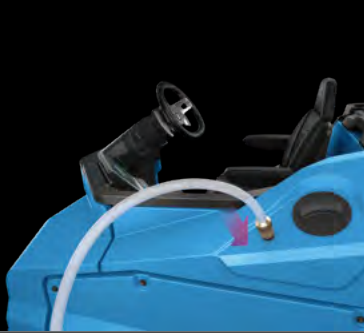

FFF-FIMAP FAST FILL

It enables the solution tank to be filled up quickly without the presence of the operator



SPRAY GUN

The spray gun enables the cleaning of the recovery tank anywhere, even when there is no available tap nearby, reducing maintenance downtime.

REAR FOOTBOARD

A convenient pull-down footboard at the rear of the machine provides easy access to the tanks and a better view for maintenance activities



MAINTENANCE TOUCH POINT

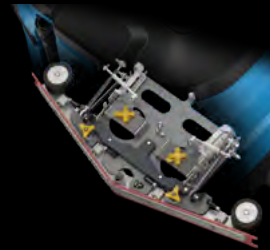

YELLOW COLOUR-CODED PARTS

Parts which must be cleaned regularly at the end of every shift are colour coded in yellow for easy identification, saving time and making sure that your scrubbing machine is kept in perfect condition at all times



LARGE DIAMETER HOSES

The large diameter of the drain hoses allows the tanks to be emptied quickly, reducing downtime. The hoses feature a flow adjustment system that enables to choose up to 5 opening sizes in order to adapt the diameter to the flow when emptying the tanks



Outstanding performance in any challenge



DUAL 3-STAGE VACUUM MOTOR

Effective vacuum system which leaves the floor dry with no risk of slipping



The layout of the squeegees helps to collect water and direct it towards the suction point, thus ensuring better drying.

The floor is perfectly dried even in bends, thanks to the lateral movement of the rear squeegee, which always follows the course of the machine.



FLR-FIMAP LONG RANGE

PRODUCTIVITY IS INCREASED BY UP TO



RUN TIME



with Li-ion batteries



* In Eco Mode

SPEED



PRODUCTIVITY

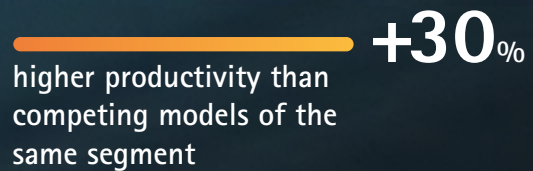



300
litres

SOLUTION
TANK

350
litres

RECOVERY
TANK



SIDE BRUSH WITH VACUUM SYSTEM

The side brush makes it easy to clean along walls and allows to reach under shelves. It is equipped with vacuum system, a unique innovation not available in any other model in the market, which increases drying performance even on bends

IT WIDENS THE WORKING WIDTH,
THUS INCREASING PRODUCTIVITY BY UP TO

+20%



GREATER CLEANING POWER TO TACKLE THE MOST STUBBORN DIRT

Adjustable brush pressure up to **250** kg

Brush rpm up to **315**



VACUUM WAND

Enables cleaning areas that are difficult to reach with the machine and completing the operation every time



GMG

A power never seen before in a scrubber dryer

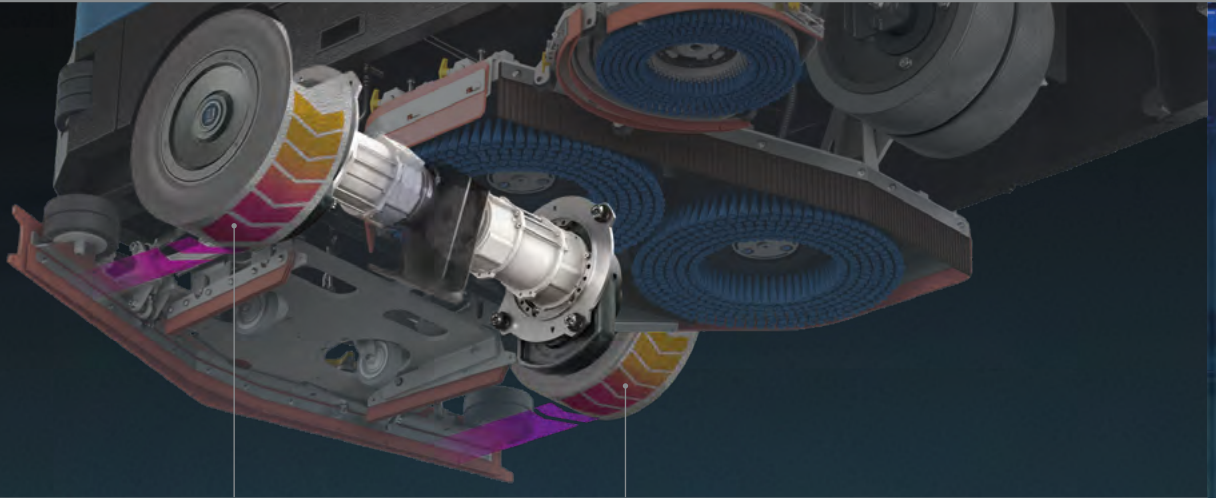

RAMP UP

REAR-WHEEL TRACTION WITH 2 INDEPENDENT MOTOR WHEELS

The rear-wheel traction with 2 electronically controlled independent wheels provides GMG with the necessary power to easily overcome ramps of up to 20% working.

In a multistorey car park, GMG is therefore able to move easily from one level to another, guaranteeing high grip when climbing, reliability and maximum control when manoeuvring.



it can clean ramps with slopes up to **20%**

it can overcome trailer ramps with slopes up to **30%***



* empty in transfer using a hoist



MINIMUM AISLE TURN

2500 mm

The combination of rear-wheel traction and independent motor wheels allows a small turning radius, which remains within the machine diagonal of 2500 mm. As a result, the space required for manoeuvring is also minimal.

The friction that is usually generated in reversing causes a significant consumption of energy, which negatively affects the working range.

The action of the independent rear motor wheels together with the double front wheel of GMG considerably reduces the friction produced when steering. This avoids unnecessary energy dispersion, extends battery run time and increases productivity.

Power steering improves comfort

The power steering makes the steering wheel lighter, increases manoeuvrability and reduces the operator fatigue while driving.



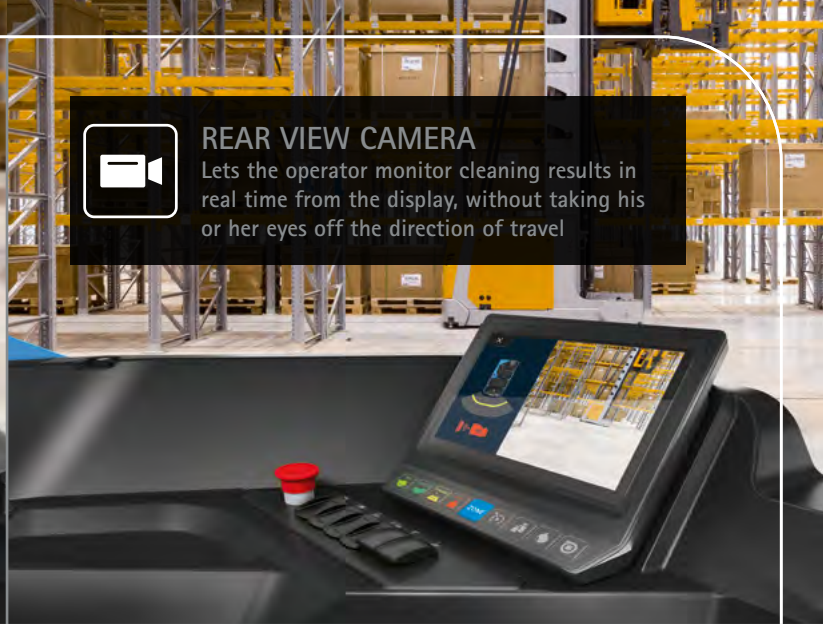

REAR VIEW CAMERA

Lets the operator monitor cleaning results in real time from the display, without taking his or her eyes off the direction of travel

FUNCTIONS TO INCREASE POWER

The Power Mode and Heavy Mode functions allow you to get the maximum cleaning power instantly, by activating just one control. Vacuuming power, brush pressure and detergent solution flow rate are raised to the highest level.



POWER MODE

A simple touch of the side paddle raises the cleaning functions to the maximum for 120 seconds. This function is effective when the operator finds a small area with adherent dirt during the cleaning operation. In this case, it is useful to temporarily leave the cleaning configuration in use in order to benefit from the maximum cleaning power to remove localised dirt.

 for **120** seconds
Maximum cleaning power



HEAVY MODE

Maximum activation of cleaning functions has no time limits. It is a working mode, suitable for very dirty environments. The operator simply presses the Heavy Mode button to start working at maximum performance for as long as it is needed.



Maximum cleaning power with no time limits!

Get access to more information to improve performance, enter the digital world of GMG

ON-BOARD COMPUTER

With the touchscreen display you have access to information that is essential to make more efficient choices and enhance the professionalism of interventions, thus increasing productivity and reducing costs.

Display at any time:



- information about the batteries, their condition and the recharges performed, both complete and opportune
- report of usage time, sq.m. cleaned and liters of water used

- telemetry to track the energy consumption of the functions

- remaining autonomy of batteries and tank, and projection of savings that can be achieved in Eco Mode

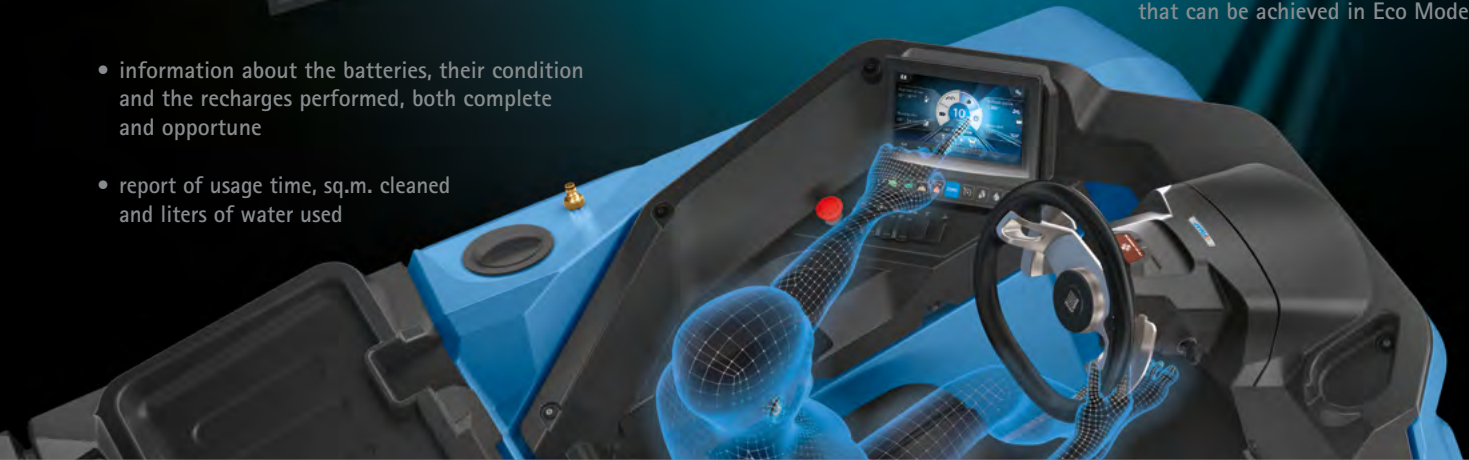

iD—intelligent Drive



TOUCH SCREEN
DISPLAY



LOG-IN
CON PASSWORD



ZONE
PROGRAMS



CRUISE
CONTROL



SUSTAINABLE
CLEANING



MAINTENANCE
CLEANING



FAST
CLEANING



HEAVY-DUTY
CLEANING



TIMED CLEANING
POWER



REAR VIEW
CAMERA



ANTI-COLLISION
SYSTEM



OPERATOR
TRAINING VIDEO
TUTORIALS



USER MANUALS
IN 24
LANGUAGES



The operator is the centre of a high-tech universe, where everything is easy, intuitive and dynamic

All functions and activities are managed from a single interface, where a mere touch of the finger offers access to an extraordinary choice of customizable features to satisfy all types of requirements with extreme simplicity.

The high definition colour display offers the same intuitive experience as a smartphone



Touchscreen Display



LOG-IN WITH PASSWORD

Protects your investment from unauthorized or improper use



REAR VIEW CAMERA

Increases safety during manoeuvres and helps control cleaning performance



OPERATOR TRAINING VIDEO TUTORIALS

Reduce training costs, providing quick instructions on how to perform ordinary maintenance operations

9 working programs to achieve the best results with the maximum efficiency



Set your goals: with zone and working programs, you reduce the risk of error, make cleaning operations effective on the first pass and achieve desired results without any uncertainty

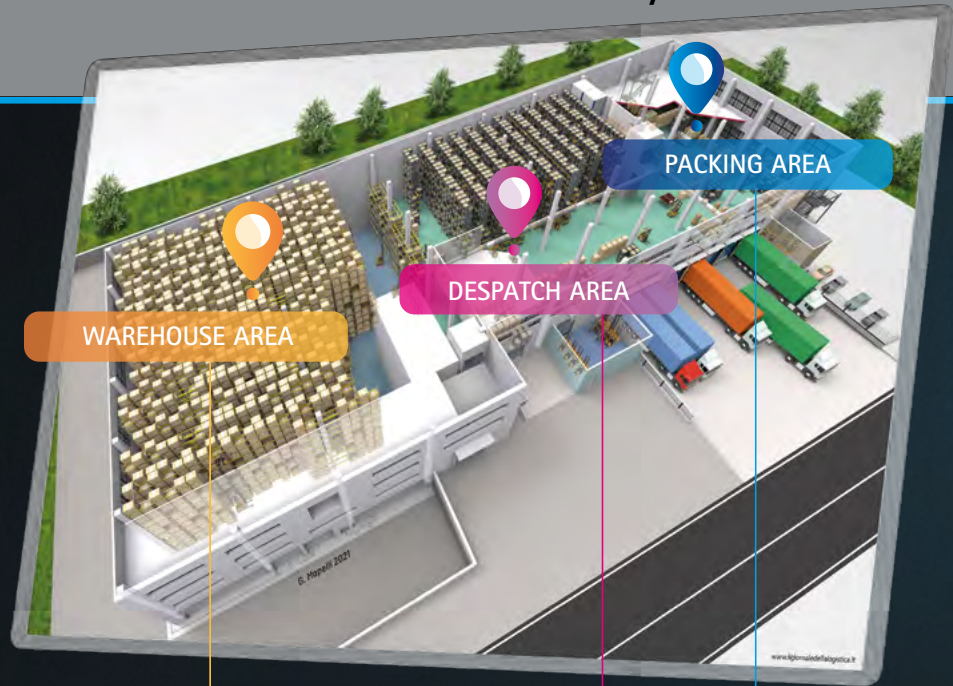

4 ZONE PROGRAMS

Set up to 4 zones that are frequent on your cleaning sites to help the operator carry out the task properly.

Save the cleaning settings you consider suitable for each zone; once the zone has been selected, GMG will start working with the configuration you set.



Working programs guide the operator through an intuitive selection of the most suitable cleaning configuration



5. ECO MODE

For light maintenance cleaning, where you can use less resources and work with a low noise level



6. COMFORT MODE

For ordinary, not heavy-duty cleaning, suitable for daily tasks



7. DYNAMIC MODE

For routine cleaning where greater productivity is required, it allows tasks to be done quickly



8. HEAVY MODE

For heavy-duty operations, to clean very dirty floors that require high cleaning power



9. POWER MODE

To get 120 seconds of maximum power and easily remove localized dirt

Some working programs can be selected from either the touchscreen display or the membrane keyboard below



GMG

Connect to your fleet, increase productivity with the My.Machine app



FIMAP FLEET MANAGEMENT

Track the performance of your fleet easily, through your smartphone, with the My.Machine app. You can see where your machines are, if the cleaning task is being carried out as planned or if any unexpected event has

occurred. Enter the profile of each scrubber dryer and check the list of servicing performed, the charger logs and anomalies occurred, in order to always be in full control of the situation and keep productivity high.

Manage your fleet remotely with the FFM – Fimap Fleet Management system,
use the My.Machine app
to access data at any time and don't miss a single detail of the status of your machines



Watch the video



GEOLOCATION

It shows on a map the machine.



USE INFORMATION

It's possible to know in what working mode the machine is operating and for how long. Moreover, it provides information about the duration of each intervention and the sq.m cleaned.



HEALTH STATUS

Anytime is possible to monitor the health condition of both machines and batteries to have a clear view of the fleet availability and optimize its coordination.



ENVIRONMENTAL IMPACT

It is possible to know the amount of CO₂ produced by the machine since the beginning of its life cycle.



ALARMS

The anomalies occurred are summarized in a list which includes a description of the type of issue, and the date and time of the event. It helps you to have an overview of the improper uses that need to be corrected.



BATTERY RECHARGE

It sums up all the complete and opportune recharges performed, the residual charge and the charge settings. This is an essential set of information to extend the battery lifespan and reduce the related costs.



SERVICES

An overview of the list of the maintenance services performed allows to identify discrepancies with the health condition of the machine in case an anomaly is detected, and to monitor the inspections of the whole fleet.

Greater control during interventions raises safety standards



REAR VIEW
CAMERA

Increases the safety of
reverse manoeuvres



ANTI-COLLISION
SYSTEM

The anti-collision system
detects obstacles
when reversing





ACTIVE TECHNOLOGIES to prevent accidents

In large spaces where there can be obstacles such as machineries or shelves, GMG always ensures full control of the surrounding space, so that the necessary manoeuvres can be carried out in the utmost safety.

Greater control during interventions raises safety standards

ACTIVE TECHNOLOGIES to prevent accidents



TOUCH SCREEN
DISPLAY

Enhances visibility in dim light



STEERING
WHEEL
CONTROLS

The steering wheel controls offer the operator even greater control when cleaning, and also improve safety by eliminating distractions and letting the operator keep his or her eyes on the zone ahead of the machine



CRUISE
CONTROL

Control device letting the operator set the required speed



DESCENT
CONTROL

Maintains a constant speed when driving downhill, and prevents sudden increases in speed caused by gravity



STOP&GO

The traction control system, which brakes and holds the machine when the accelerator pedal is released, provides assistance for both uphill and downhill gradients



ELECTROBRAKE

Is automatically operated when the machine stops. It works as a safety parking brake



HYDRAULIC
DRUM BRAKES

Self-adjusting, guaranteeing the best braking performance



ESC - ELECTRONIC
STABILITY CONTROL

Automatically reduces speed when steering without the operator using the brake

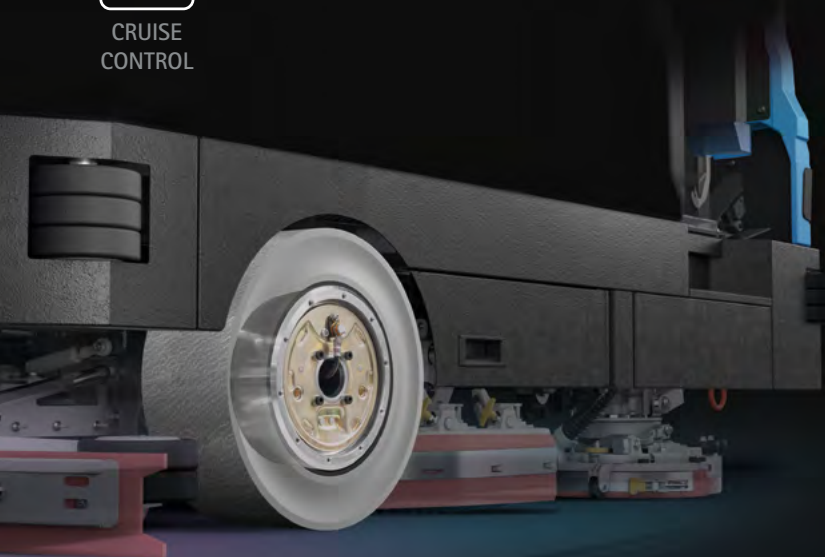



Protect the operator holding him/ her in case of impact

SAFETY BELTS



To protect operators working in warehouses and logistics centres

OVERHEAD GUARD



Warns about the presence of GMG when visibility is obstructed by shelves or other equipment, avoiding accidents

BLUE SAFETY SPOTLIGHT



Front and rear LED headlights maximize work safety in all conditions

LED HEADLIGHTS



Any questions? GMG has all the answers: the video tutorials help the operator in every phase of the job

OPERATOR TRAINING VIDEO TUTORIALS



Position lights / Brake lights

Reverse lights

Driving lights

Position lights

PASSIVE SYSTEMS to help the operator in case of emergency



SOS DEVICE

Reduces time to service in case of emergency. The red button sends an sms alert to receive a prompt help, reducing downtimes



EMERGENCY STOP

By pressing a single button the machine stops immediately

Choose how to reduce the environmental impact of cleaning operations with Fimap sustainable technologies

GMG always shows you the advantages of a more eco-friendly option

During the cleaning intervention, a projection of how many resources could be saved by activating Eco Mode is shown on the display. In this way the operator can evaluate, if the dirty conditions allow it, to switch to a cleaning configuration that reduces consumption.



The Eco Mode device helps you to not use more resources than necessary. When just a maintenance cleaning is required and dirt is light, you can clean using reduced amounts of water, chemical and energy. By avoiding waste, you can clean more sq.m with less resources



START&STOP

When the machine is idle, the brush motor, the vacuum motor, the traction and the water flow will turn off automatically, reducing costs and emissions.

All the functions are reactivated automatically as soon as the operator touches the accelerator again

WATER



FSS
FSS-FIMAP SOLUTION SAVER
The amount of water and chemical are dosed separately

It reduces water and chemical use by up to **50%**



FLR
FLR-FIMAP LONG RANGE
System that recycles the cleaning solution, increasing the working autonomy

It reduces water and chemical use by up to **66%***



FWF
FWF-FIMAP WATER FLOW
Ensures uniform cleaning results across the entire working width on the first pass, optimising detergent solution consumption

ENERGY



FES
FES-FIMAP ENERGY SAVER
LED TECHNOLOGY
Up to 80% lower energy consumption than conventional headlights.
The LED headlights consume much less energy than conventional headlights, offer a longer lifespan and illuminate with a brilliant white light similar to natural daylight

It reduces energy consumption by up to **35%**

* Per cleaning operation. Saving calculated on a triple recycling cycle

GMG

Choose the version that meets your needs



DUAL DISC
with 2 disc brushes
or 2 pad holders



CYLINDRICAL
with 2 cylindrical brushes and
a debris hopper for small sized
solid debris

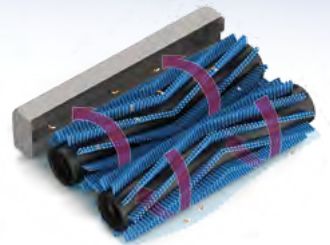



Touch screen display

PLUS



Membrane control panel

PRO



Customize your GMG with the most suitable accessories for your industry

OPTIONALS



Vacuum wand



Spray gun



The Comfort seat is adjustable and complete with armrests and safety belt



Super elastic wheels



FFF-FIMAP FAST FILL

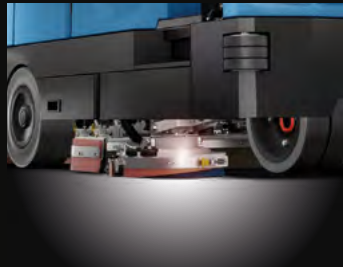

Side scrubbing brush with vacuum system



FFM-FIMAP FLEET MANAGEMENT



Front and rear LED headlights



Service LED lights



Overhead guard



BLUE SAFETY SPOTLIGHT



Power steering



FSS-FIMAP SOLUTION SAVER



FLR-FIMAP LONG RANGE



Antibacterial tanks help inhibit the growth of bacteria and mold



You can equip your GMG with tanks made with recycled plastics

ACCESSORIES



CENTRAL SCRUBBING BRUSHES



SIDE BRUSHES



CENTRAL SWEEPING BRUSHES

A selection of disc or cylindrical brushes is offered for dealing with any type of dirt on any floor

Abrasive brushes:

Suitable for heavy-duty cleaning of industrial floors

The application of a pad holder allows the use of various types of pads according to the treatment to be performed



REAR SQUEEGEE RUBBER BLADES

33 SHORE (PARA): For maintenance cleaning of smooth floors

40 SHORE (PARA): For stubborn dirt on floors with joints

POLYURETHANE: For heavy-duty cleaning and collecting oil on industrial floors

LINATEX™: Suitable for all surfaces from smooth to uneven, they provide excellent performance because they are more resistant to wear, temperature changes and use of aggressive chemicals

OPTIONAL AND STANDARD EQUIPMENT

USER EXPERIENCE	DUAL DISC		CYLINDRICAL	
	GMG Pro	GMG Plus	GMG Cylindrical Pro	GMG Cylindrical Plus
iD-Intelligent Drive:	-	•	-	•
- 9 inch high resolution color touch screen	-	•	-	•
- Log-in with password	-	•	-	•
- Zone programs	•	•	•	•
- Cruise control	•	•	•	•
- Eco Mode	•	•	•	•
- Comfort Mode	-	•	-	•
- Dynamic Mode	-	•	-	•
- Heavy Mode	-	•	-	•
- Power Mode	-	•	-	•
- Power	•	-	•	-
- Digital solution level indicator	-	•	-	•
- Rear view camera	-	•	-	•
- Anti-collision system	-	•	-	•
- Operator training video tutorials	-	•	-	•
- User manuals in 24 languages	-	•	-	•
- On-board computer (odometer, battery status, telemetry, report of the last cleaning intervention, remaining autonomy)	-	•	-	•
- Membrane keyboard with work mode selector	-	•	-	•
Membrane control panel	•	-	•	-
COMFORT				
Hour meter	•	•	•	•
Cleaning solution level indicator	•	•	•	•
Fresh water empty tank light	•	•	•	•
Vacuum wand	○	○	○	○
Spray gun	○	○	○	○
Basic seat	•	-	•	-
Adjustable Comfort seat complete with armrests and safety belt	○	•	○	•
FFF (Fimap Fast Fill)	○	○	○	○
Automatic brush uncoupling of the central scrubbing brush head	•	•	-	-
Noiseless suction	•	•	•	•
Brush and squeegee actuator	•	•	•	•
Power steering	○	○	○	○
Super elastic wheels	○	○	○	○
Rear footboard for easy maintenance	•	•	•	•
USB ports for charging mobile devices	•	•	•	•
PRODUCTIVITY				
Water flow selector	•	•	•	•
Triple pressure selector	-	•	-	•
Extra pressure	•	-	•	-
Vacuum speed selector	•	•	•	•
Side scrubbing brush with vacuum system	○	○	-	-
2 3-stage vacuum motors	•	•	•	•
FFM (Fimap Fleet Management) with SOS device	○	○	○	○
Stainless steel squeegee	•	•	•	•
Side splash guards	•	•	•	•
Rear-wheel traction with 2 independent motor wheels	•	•	•	•
Brushless motors (traction, brushes, vacuum)	•	•	•	•
Batteries with automatic refilling system	○	○	○	○
Ramp up	•	•	•	•
SAFETY				
Blinking light	•	•	•	•
Driving LED lights (front-rear)	○	•	○	•
Service LED lights	○	•	○	•
Stop&Go	•	•	•	•
Descent control	•	•	•	•
ESC (Electronic Stability Control)	•	•	•	•
Emergency Stop	•	•	•	•
Overhead guard	○	○	○	○
Antibacterial tanks*	○	○	○	○
Blue safety spotlight	○	○	○	○
Hydraulic rear drum brakes	•	•	•	•
Electrobrake	•	•	•	•
ENVIRONMENT				
FSS (Fimap Solution Saver)**	○	○	○	○
FLR (Fimap Long Range)**	○	○	○	○
FWF (Fimap Water Flow)	•	•	-	-
FES (Fimap Energy Saver)	•	•	•	•
Start&Stop	•	•	•	•
Tanks made of recycled plastic*	○	○	○	○

(*) It is not possible to have both types of tank on the same machine

(**) The two devices cannot be installed together

DIMENSIONS AND TECHNICAL DATA

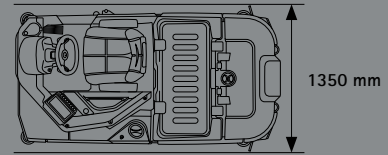
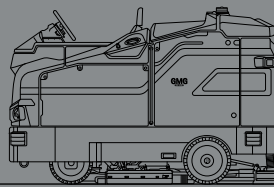
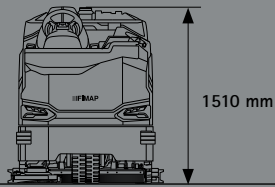

2310 mm

TECHNICAL DATA – GMG		DUAL DISC		CYLINDRICAL	
		GMG Pro	GMG Plus	GMG Cylindrical Pro	GMG Cylindrical Plus
Productivity theoretical	up to sqm/h	12000		13000	
Estimated coverage	up to sqm/h	10800		11700	
SCRUBBING SYSTEM					
Working width	mm	1000			
Working width with side brushes	(no.) mm	(1) 1200		(2) 1300	
Brush motors	(no.) V/W	(2) 36/1500		(2) 36/1500	
Brush rpm (central / side)	rpm	315/140		625/75	
Brush pressure	up to kg	250			
TANK AND RECOVERY SYSTEM					
Solution tank	l	300			
Recovery tank	l	350			
Suction motor	V/W	(2) 36/600			
Vacuum water lift	mbar	200			
Detergent tank capacity (FSS)	l	32			
Maximum volume of the debris hopper	l	-		47,5	
BATTERY SYSTEM					
Supply/traction	V	36/aut.			
Batteries	(no.) V/Ah	(1) 36/510-625-775 WET - 38,4/720 Li-ion			
Battery run time*	up to h	6 (WET) - 10 (Li-ion) *			
PROPELLING SYSTEM					
Forward working speed	km/h	9			
Transport speed	km/h	10			
Gradeability (Working / Transport at gross weight / Trailer ramp empty)	%	20 / 25 / 30**			
Traction motor	(no.) V/W	(2) 36/3300			
SPECIFICATIONS					
Machine dimensions (L x h x w)	mm	2310		1510 1250	
Squeegee width	mm	1350			
Machine weight empty without batteries	kg	986		1041	
Machine weight empty with batteries	kg	1795		1850	
GVW (Gross Vehicle Weight)	kg	2215		2280	
Sound pressure level (ISO 11201) – L _{PA} – Eco Mode	dB (A)	67			
Minimum aisle turn	mm	2500			

*Run times are based on continuous scrubbing run times

**With hoist

SERVICES

CONSULTING AND PLANNING



We put our experience at your service, to help you realize the cleaning project perfect you. We suggest you the best solutions to make costs decrease and service quality increase.

SETUP



We can help you set up your machines in order to make them meet specifically the requirements of the sites of your project, allowing you to always have control over costs and results.

AUTHORIZED WORKSHOP NETWORK



Fimap Authorized Workshop network spans the globe, so you can enjoy the peace of mind of finding a professional support wherever your business is.

CONFIGURATION



Your business is unique, only a customized fleet can lead you to better results. We will help you find the configurations that best fit the specific requirements of your cleaning sites, in order to optimize processes and lower costs.

TRAINING COURSES



Fimap Academy offers courses for all levels, from the correct use of machines and technologies, up to the management of sites and tenders, helping you to make your service really competitive.

MAINTENANCE AND REPAIR



For your business to run smoothly it is essential that your machines are kept always operational. Our technicians take care of monitoring the machines health status and know how to intervene quickly and effectively when needed.

FINANCIAL SOLUTIONS



You can choose to use the fleet in different ways. We can advise you on the best financial solution for your business, so that you can get the quality of the Fimap world at the most convenient conditions for you.

DIGITAL FLEET MANAGEMENT SYSTEM



With Fimap Fleet Management everything is under your control. You can have a complete overview of the service provided and find out the improvements that can be made, basing your considerations on real data, always available via the MyMachine app or FFM website.

GENUINE SPARE PARTS



Get the most out of your machines, choose the reliability of Fimap original spare parts. They are designed together with the machines, so they perfectly fit them thus guaranteeing the highest quality of performance.

CERTIFICATIONS



For any additional information or for a demo please contact your usual Fimap dealer



FIMAP spa - Via Invalidi del Lavoro, 1 - 37059 S. Maria di Zevio - Verona - Italy
Tel. +39 045 6060411 - Fax +39 045 6060417 - E-mail: fimap@fimap.com

